

PPA4500 Series
PPA5500 Series



Product Overview

Leading wideband accuracy	Basic 0.01%(PPA5500) with class leading high frequency performance
New Voltage Attenuator Design	3.3Mohm, Low burden and heat dissipation, Maintaining excellent frequency response and Linearity
Wide frequency range	DC, 10mHz to 2MHz
Fast sample rate and No-Gap	2.2M samples/s
Leading phase accuracy	0.005 Degrees plus 0.01 degrees per kHz (0.003 Degrees - Transformer Edition)
Built in high precision current shunt	10Arms, 30Arms or 50Arms with up to 1000Apk direct plus a wide range of external sensors
Versatile interfaces	RS232, USB, LAN, GPIB as standard (PPA5500) plus direct torque and speed
Range of PC software options	Remote control, monitoring and recording of real time data, tables and graphs
PWM Motor Drive Measurements	Highest performance Analyzer on the market for PWM Motor Drive Evaluation
External Voltage BNC Connector	Unique External BNC connector with high sensitivity to interface with external High Voltage Probes
HF + TE Accuracy	Increased High Frequency and Low Power factor as standard, -HF and -TE certification optional

PPA5530 Precision Power Analyzer

FRONT VIEW



① POWER BUTTON

② FRONT USB PORT

USB memory port allows data or screendumps to be saved directly to a USB pen drive

③ DISPLAY SCREEN

White LED backlight colour TFT display with high contrast and wide viewing angle

④ SCREEN DISPLAY OPTIONS

Zoom, Real time, Table and Graph options

⑤ MEASUREMENT FUNCTION SELECTION BUTTONS

- POWER ANALYZER
- POWER INTEGRATOR
- HARMONIC ANALYZER
- TRUE RMS VOLTMETER and AMMETER
- IMPEDANCE METER
- OSCILLOSCOPE



Measurement Mode Quick Access Buttons

⑥ MEASUREMENT SETTINGS BUTTONS

Acquisition settings - Sets wiring configuration, Smoothing and data logging

Coupling - Set coupling to AC, DC or AC+DC, also set bandwidth

Range - Internal or external attenuator, autoranging settings, scale factors

Application mode - PWM, ballast, inrush current, power transformer, standby power, IEC61000 (PPA5500)

Plus direct configuration of - Alarm, Auxiliary, Remote, System and Program functions

⑦ MENU SELECTION AND CURSOR CONTROL

⑧ START, STOP, ZERO AND TRIGGER

Trigger button refreshes measurement, Zero resets datalog or allows an offset trim

Start and Stop buttons provide manual control of a measurement period

REAR VIEW



PPA45/5530 (3 Phase)

⑨ PHASE INPUTS

Direct voltage Input: 3kVpk (1kVrms) in 9 ranges*

Direct current Input: 300Apk (30Arms) Standard Model, 30Apk (10Arms) Low Current Model, 1000Apk (50Arms) High Current Model

External voltage and current sensor inputs to 3Vpk in 9 ranges* - BNC Connector

⑩ SYNC CONNECTOR

All PPA models can offer up to 12 phase analysis using the PPALoG PC program
Additionally two PPA45/5530's can be connected via the extension port and sync BNC connector to form a 6 phase analyzer when a PC is not available

⑪ EXTERNAL SENSOR INPUTS

+/-10V or pulsed input from torque and speed sensors provides direct measurement of mechanical power + analogue output

⑫ PC INTERFACE CONNECTIONS

Standard interfaces RS232 + USB + LAN + GPIB (Standard on PPA5500, GPIB optional on PPA4500)

⑬ LOW NOISE COOLING FANS

Air bearing low noise fans are utilized to ensure minimum audible and electrical noise while maintaining a stable operating temperature for the high precision low inductance internal current shunts

*PPA4500 - 8 ranges



FEATURES

High Speed Power Measurement - 2ms* Datalog Interval PPA5500 PPA4500

Measurements include all frequency components in power waveforms for example, fundamental, harmonics of the fundamental and the carrier of a PWM inverter output by maintaining 2.2Ms/s sampling at any drive frequency

※PPA4500 10ms datalog interval

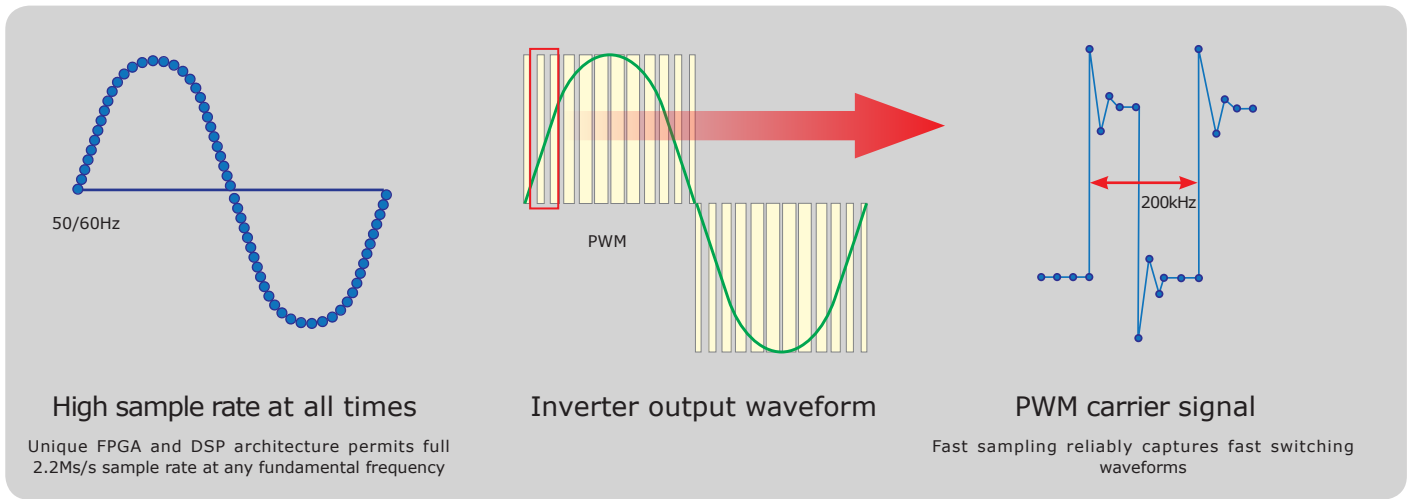

2MHz Wideband Frequency Response PPA5500 PPA4500

With 2MHz bandwidth and exceptionally flat response, the PPA provides precision analysis of total power in applications such as lighting ballasts or PWM drives that involve a wide range of frequency components. Proprietary to N4L, a digital process called Expanded Nyquist Sampling ensures no alias components

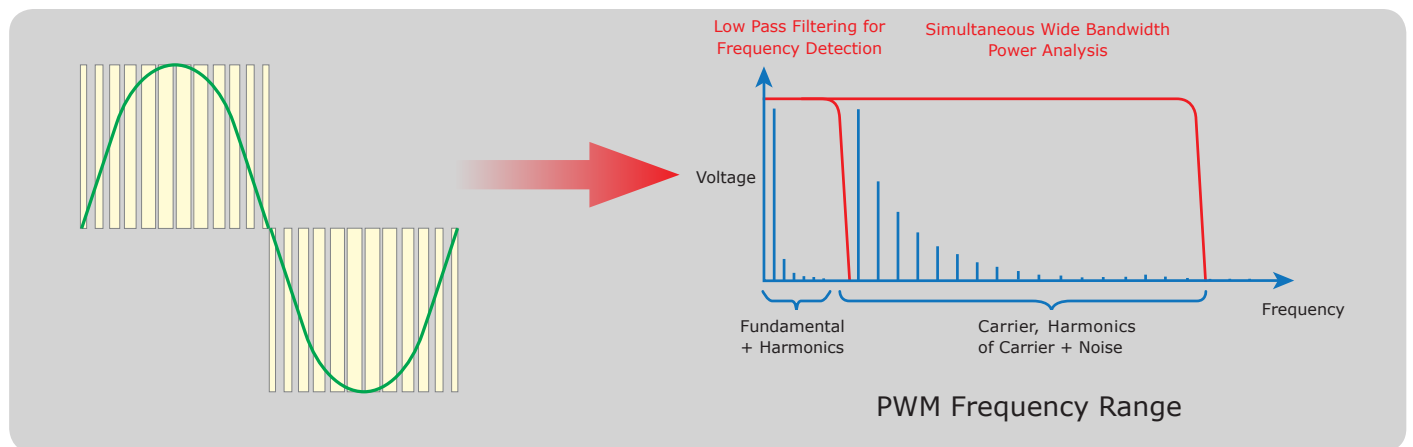

High Accuracy PPA5500 PPA4500

Unique voltage and current analogue card design ensures high accuracy for both power and harmonic analysis

Class Leading Power Accuracy

PPA5500-HF Power Accuracy: $[0.03\% + 0.03\%/pf + (0.005\% \times kHz)/pf]$ Rdg + 0.03%VA Rng*
@ 220V (300V Range), 2A (3A Range), Power Factor 1 [40-850Hz 0.01%VA Rng*]

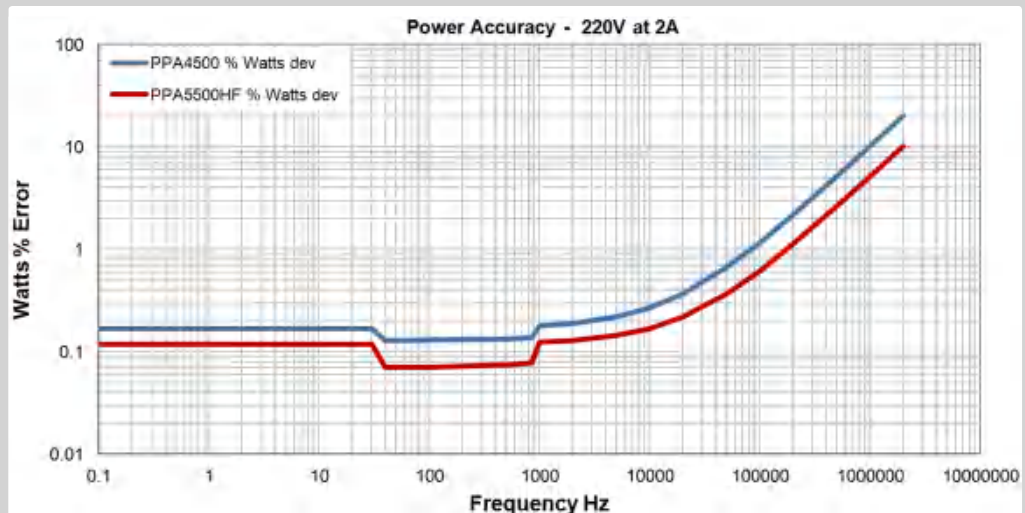

DFT Real Time No Gap Analysis PPA5500 PPA4500

Many power applications have fast changing asynchronous current pulses which are not suited to fixed data length FFT analysis. The PPA series combine a real time DFT (Discrete Fourier Transform) technique with variable window no gap analysis to ensure the optimum speed and accuracy at all times

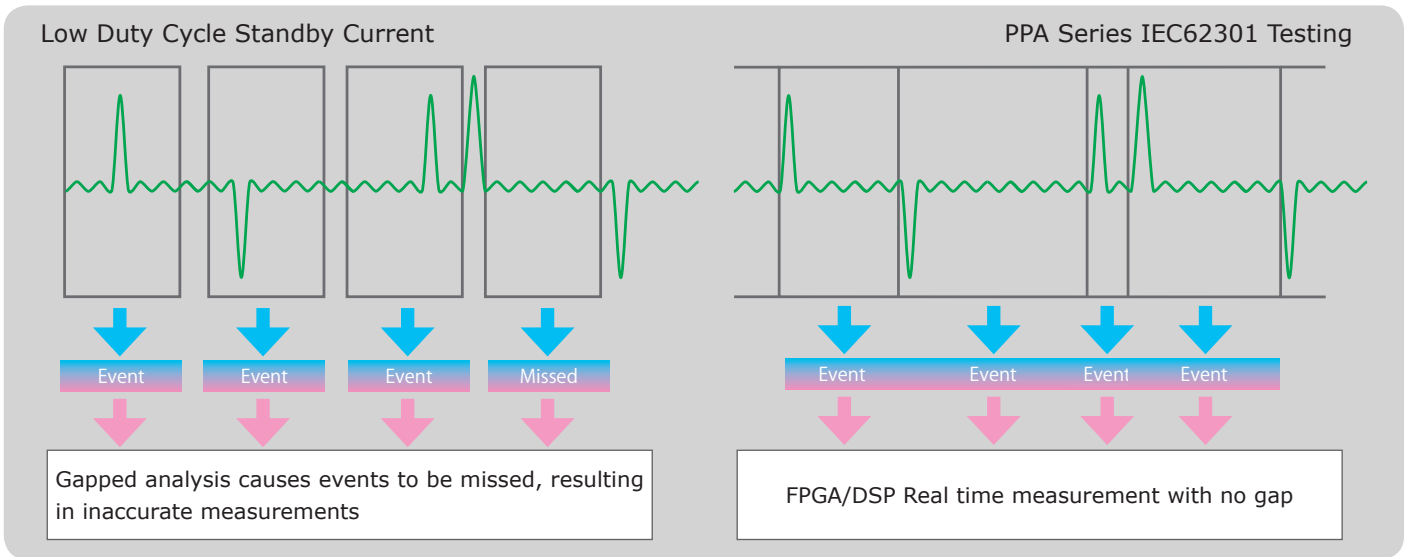

- Missing data compromises power accuracy
- Long term measurement integration achieves approximately correct average power

- Real Time No Gap analysis ensures correct power measurement
- Simultaneous fundamental and pulse frequency synchronization quickly obtains the correct power

Up to 6 Phase Analysis PPA5500 PPA4500

Master/Slave mode enables two PPA45/5530's to be fully synchronized into a single 6 phase measurement system
 ※4 or more phase measurements provided via N4L PC software or master slave mode

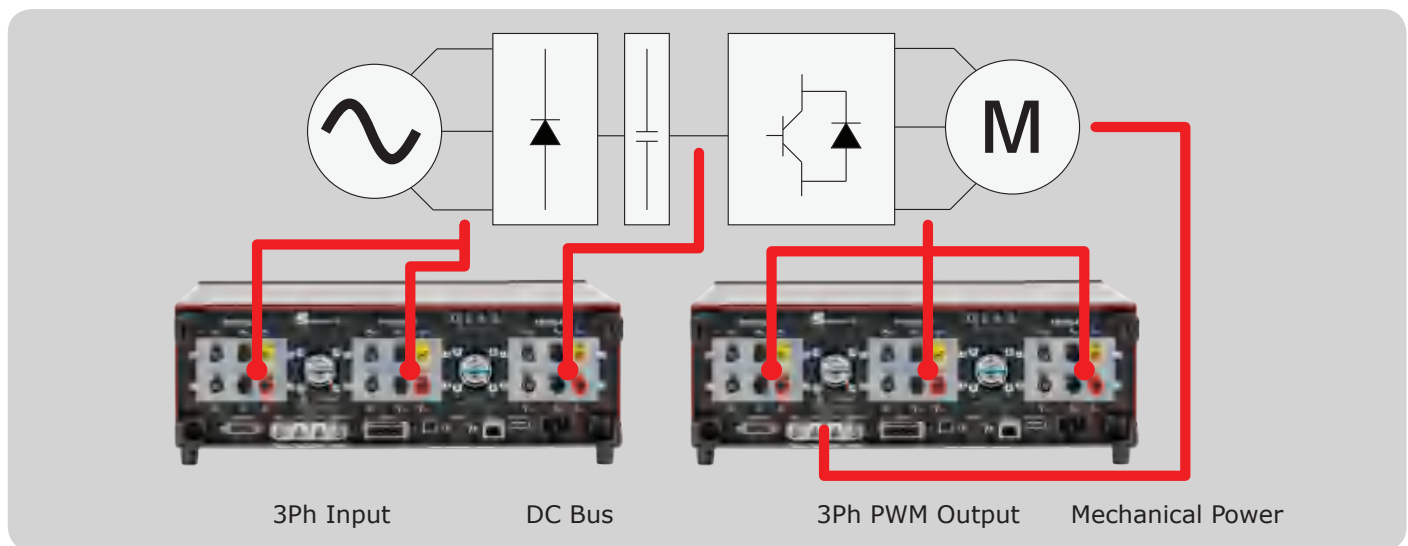

Advantages of Dual PPA vs Single instrument

- Twice the processing power as one unit
- Flexibility between different applications
- Units fully synchronized giving single point of control

Measurement parameter examples

- Input/Output power measurement
- Efficiency of the inverter
- Inverter output voltage harmonics
- Motor drive characteristics



FUNCTIONS

Input Torque and Speed Sensor PPA5500 PPA4500

Direct measurement of torque and speed from dedicated inputs that are fully synchronized with the voltage and current channels permits true real time power conversion efficiency to be evaluated



- ①TORQUE Bipolar±10V / pulsed
- ②SPEED Bipolar±10V / pulsed
- ③ANALOGUE Analogue output of selected function ±10V

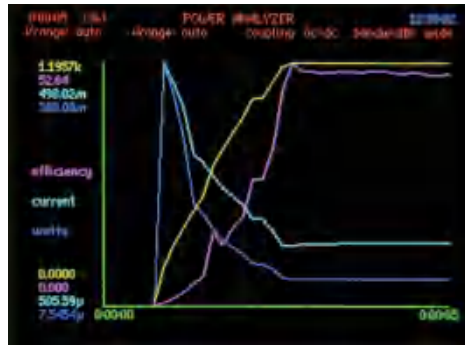

Graph



Real time data

Built in Amplifier and Unique Shunt Resistor PPA5500 PPA4500

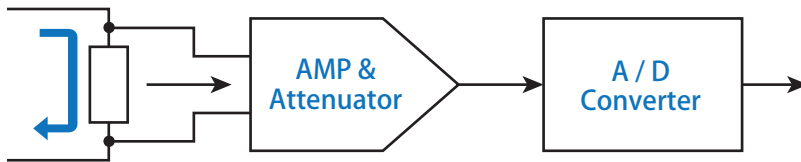

The PPA series use a single shunt resistor unique to N4L that combines exceptional linearity and no need for relay switching which can cause measurement errors

Model	Low Current Model	Standard Model	High Current Model
PPA5500	9 ranges: 3mApk - 30Apk (10Arms) 100mΩ Shunt	9 ranges: 30mApk - 300Apk (30Arms) 10mΩ Shunt	9 ranges: 100mApk - 1000Apk (50Arms) 3 mΩ Shunt
PPA4500	8 ranges: 10mApk - 30Apk (10Arms) 100mΩ Shunt	8 ranges: 100mApk - 300Apk (30Arms) 10mΩ Shunt	8 ranges: 300mApk - 1000Apk (50Arms) 3mΩ Shunt

External shunt options

(DC ~ 1MHz, 0.1% Accuracy, Inductance < 1nH)

Model	Maximum Current		Bandwidth
	Rated A	Peak	
HF500	500Arms	5000Apk	DC ~ 1MHz
HF200	200Arms	2000Apk	
HF100	100Arms	1000Apk	
HF020	20Arms	200Apk	
HF006	6Arms	60Apk	
HF003	3Arms	30Apk	



HF003



HF500



MEASUREMENT DISPLAY

Power Analysis PPA5500 PPA4500

Any parameters can be enlarged with the zoom function



Zoom function enabled on total watts, rms voltage, rms current and frequency



3 Phase analysis display selectable in both Total and Fundamental values

All power measurement and RMS values are computed simultaneously allowing measured values to be selected and viewed during analysis

Here, three phase total power is selected with all primary power functions in each phase plus frequency, a selected harmonic, dc watts and phase to phase voltage

Mechanical power, Maths and Efficiency functions can also be added to this screen giving real time analysis of electrical or electrical to mechanical systems

MEMORY

Large 1GB (PPA5500 series) internal memory, data logging from 2ms intervals with synchronization to the fundamental frequency and no gap between measurements

Datapoint storage up to 10M in the PPA5500 series

Alternatively the data can be stored in an external USB pen drive or directly to PPALoG PC software

Voltage, Current, Frequency and Power - Examples of graph mode

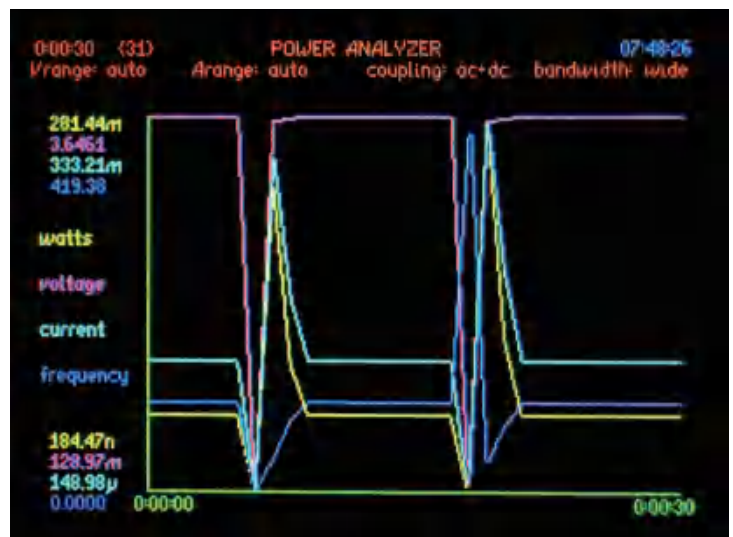

Trend analysis

MEASUREMENT MODES

Power Integrator (power consumption) Mode, RMS Meter Mode and Impedance Meter Mode

PPA5500 PPA4500



Power Integrator mode

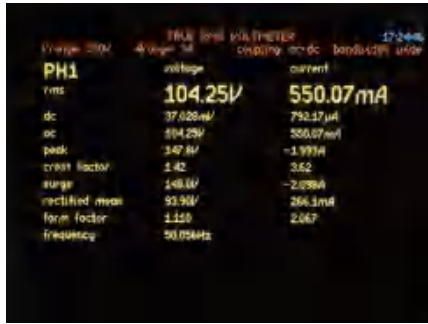

RMS Voltmeter mode



Impedance meter mode

Note

In addition to detailed measurements of the phase power parameters, you can check the balance of power between the phases and observe computed neutral current when 3 phase 4 wire connection is selected

Harmonic Analyzer and Oscilloscope

PPA5500 PPA4500

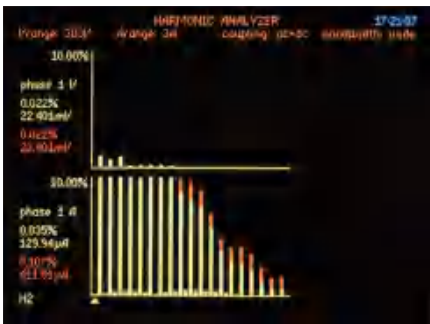

Harmonic analyzer (Bar graph)



Harmonic analyzer summary page



Harmonic analyzer table

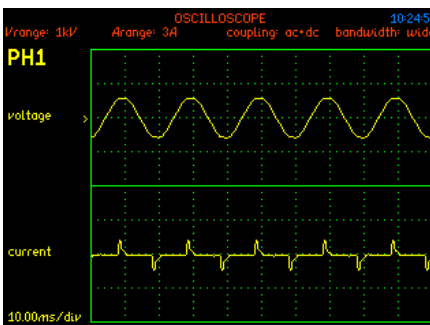

Oscilloscope - Voltage and Current display

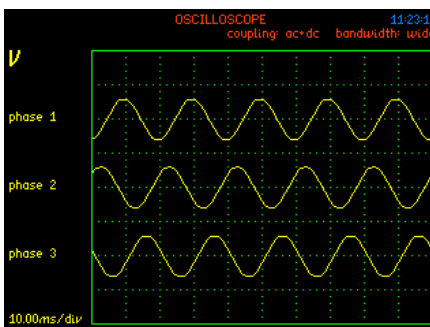

Three phase display of voltage or current

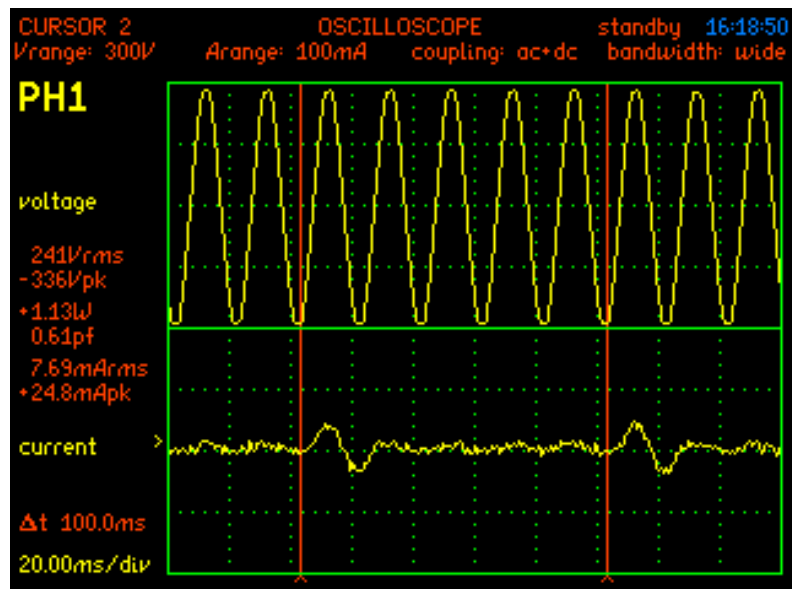

Oscilloscope Cursors - Enable cursors and display Vrms, Vpk, Watts, Power Factor, Arms and Apk

Note

In Harmonic Analyzer Mode, the PPA4500 provides up to 100 Harmonics with real time, table or bar graph presentation. Measurements are in absolute magnitude and percentage of fundamental with harmonic phase also available. The PPA5500 extends the harmonic range to 417 for aerospace applications and also includes a DFT based interharmonic analysis mode for aircraft standards testing (TVF105)

ACQUISITION SETTINGS

Auto-Ranging, Range Up Only or Manual PPA5500 PPA4500

Range modes are selectable

- ① Auto-Ranging Performs automatic switching of voltage and current ranges up and down depending on the level of the measured value with all inputs linked or ranged independently to ensure optimum accuracy
- ② Range up only Performs automatic ranging when the input is 120% of range, ranging up only
- ③ Manual No automatic ranging, user specifies the range in which to operate (used when input voltages and currents are known) or during inrush current testing

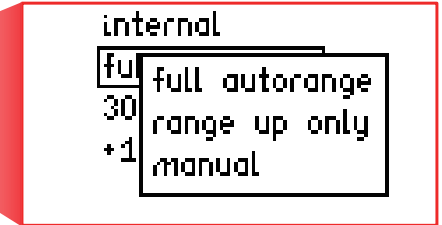
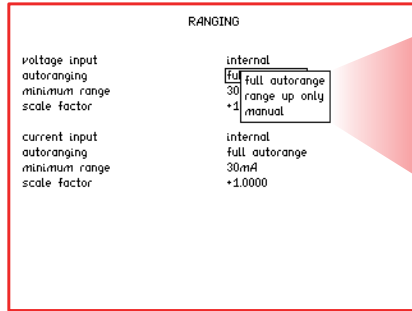
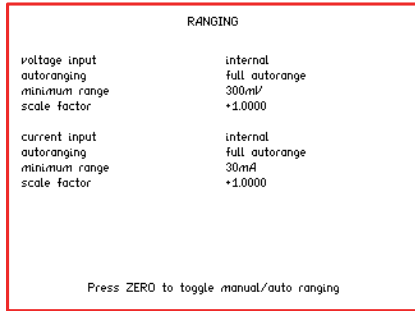

Independently Set Input Coupling PPA5500 PPA4500

Independently set input coupling so different methods of sensing can be implemented. Such as a CT on phase 1 and shunt sensing on phases 2 + 3

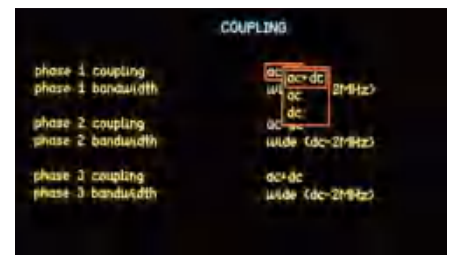
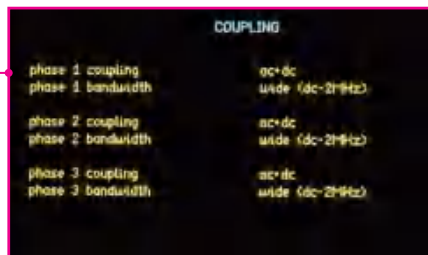
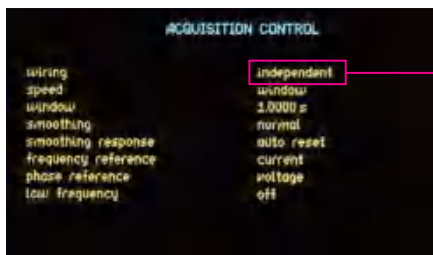

Wiring Settings PPA5500 PPA4500



Various wiring arrangement settings to satisfy a complete range of setups found in power analysis

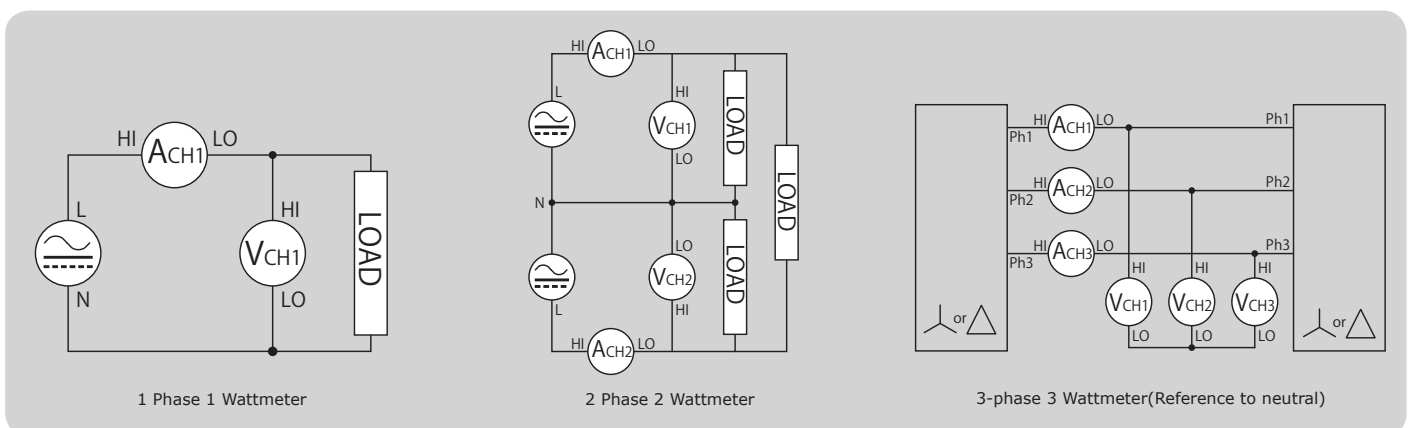

ACQUISITION SETTINGS

Bandwidth Settings PPA5500 PPA4500

- DC(DC-5Hz) DC measurements up to 5Hz
- Low(DC-200kHz) Basic power (50/60Hz) including harmonics of the fundamental while rejecting high frequency noise
- Wide(DC-2MHz) Wideband applications such as PWM inverter drives including all power components for true total power

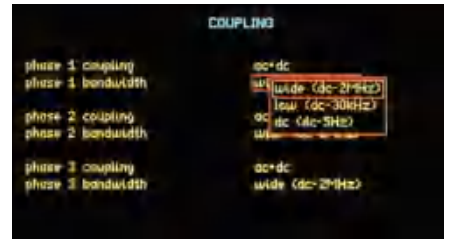

Example of independent wiring configuration showing 3 phase individual coupling settings

Note

The PPA45/5500 series includes a programmable digital filter that allows users to set a preferred bandwidth

Display Settings, Smoothing Response and Frequency Reference PPA5500 PPA4500

① Display update rate

Various settings for the display update rate (2ms ~ 100s) which also increases the smoothing when used together with the smoothing option. A 'window' option permits direct control of the measurement window size (Note: Minimum window size for PPA4500 - 10ms)

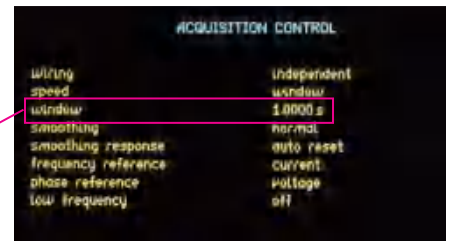
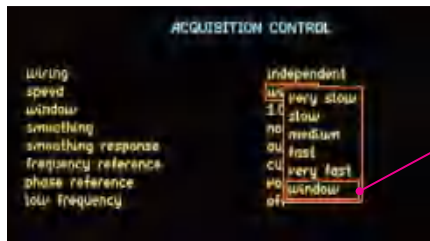

Example of setting the window, eg (50Hz set to 20ms)

② Smoothing settings

Working in conjunction with the speed setting, a smoothing filter can then be applied to the measurements. Normal and slow options are available which apply an increasing time constant to the output of the measurement window

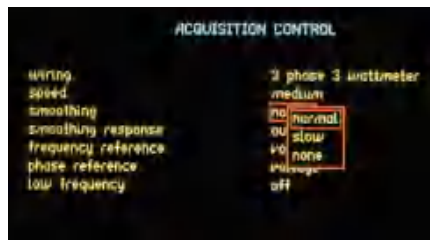

speed	update rate	normal time constant	slow time constant
Very Fast	1/80s	0.05s	0.2s
fast	1/20s	0.2s	0.8s
medium	1/3s	1.5s	6s
slow	2.5s	12s	48s
very slow	10s	48s	192s

- Display update speed settings
- Setting the filter (normal/slow)

Frequency Reference PPA5500 PPA4500

When making a precision measurement of ac power, correct synchronization with the fundamental frequency is essential. The PPA series provides a solution to frequency synchronization in a wide range of applications including Standby Power, Variable Speed Drives, Electronic Ballasts and DC to AC Inverters with the option to select voltage, current, speed or ac line input as the frequency reference. The PPA45/5500 series also provide fully independent frequency detection on all phase inputs

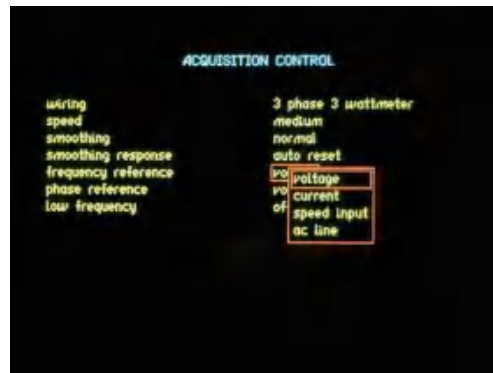

Frequency Reference

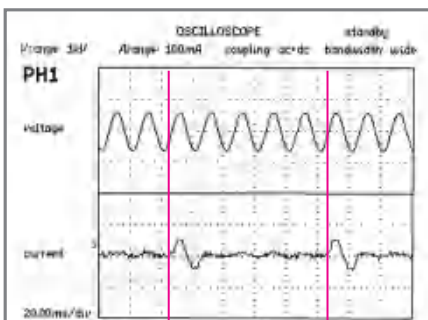

1:5 cycle (10Hz standby current period)
Power measurements synchronized to low duty cycle current pulses of a power supply in standby mode

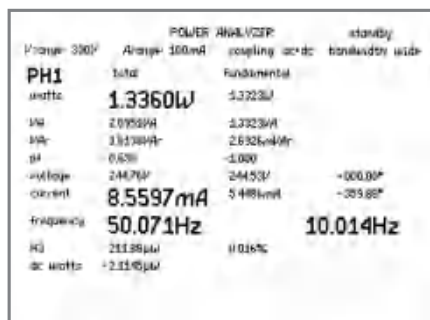

1:5 duty cycle standby power measurement cycle

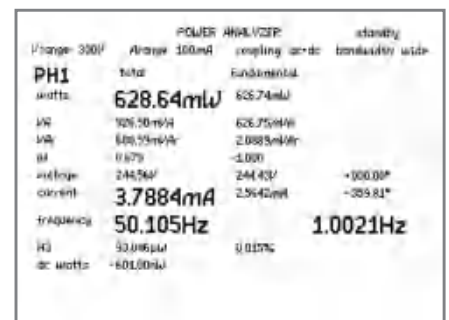

1:50 low duty cycle (1Hz) power measurement

APPLICATIONS

Application Modes PPA5500 PPA4500

In addition to the usual power measurements, various modes are pre programmed into the instrument including "PWM motor drive", "ballast lighting system", "inrush current", "power transformer", "Harmonics and Flicker*", "TVF105*" and "standby power" *PPA5500 only

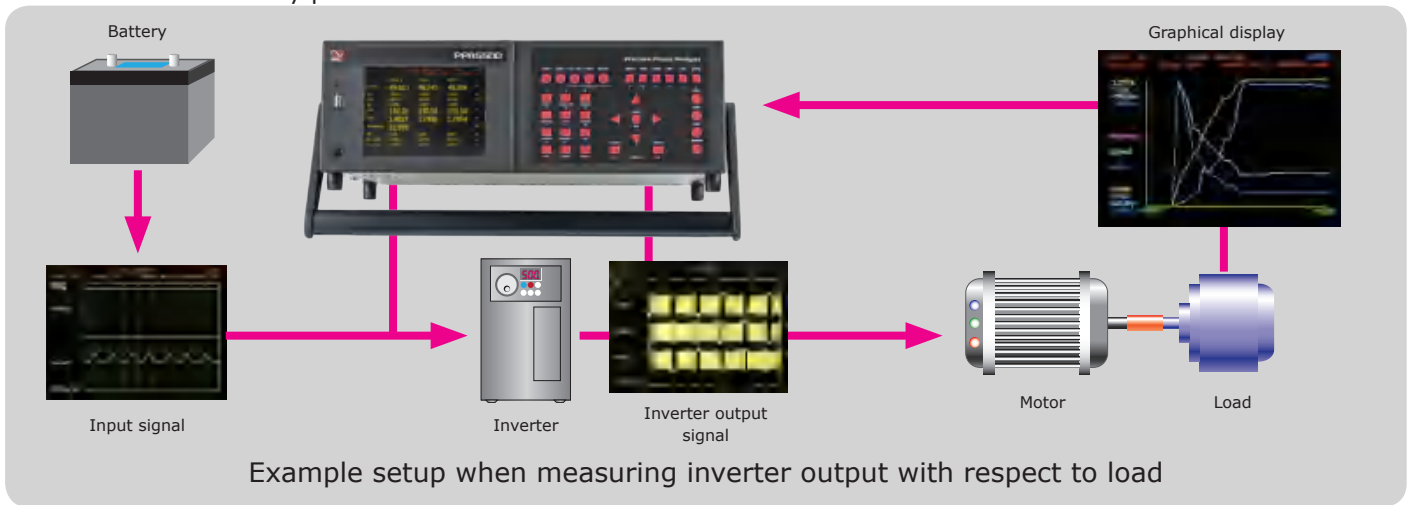

APPLICATION SELECTION

```

mode
default settings
frequency filter
frequency reference
low frequency
torque + speed
efficiency

PWM motor drive
press ENTER to load

4kHz
voltage
off
disabled
analogue speed
pulsed speed
    
```

APPLICATION SELECTION

```

mode
default settings
frequency filter
frequency reference
low frequency
torque + speed
scale factor
offset
scale factor
offset
efficiency

PWM motor drive
press ENTER to load

4kHz
current
off
analogue speed
+1.0000 Nm/V
+0.0000 V
1.0000 rpm/V
+0.0000 V
mechanical / sum
    
```

Scale factor of analogue speed and torque inputs

Inductance Loss Analysis PPA5500 PPA4500

An example of analysis of dynamic inductance losses

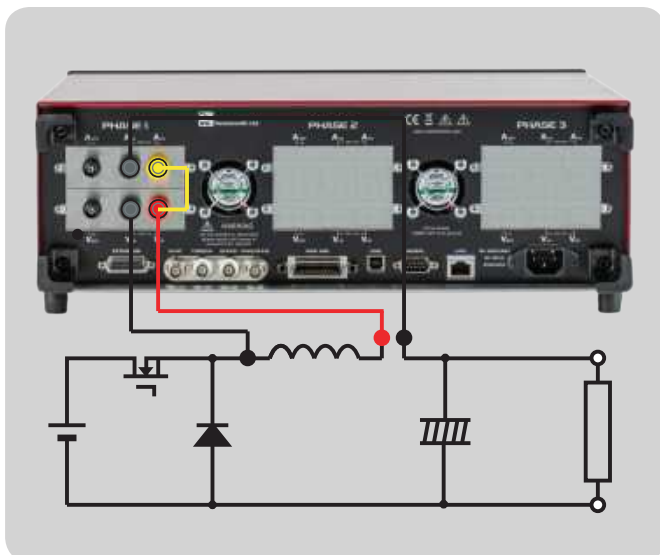

POWER ANALYZER			
PH1	total	fundamental	
watts	23.813mW	11.320mW	
VA	325.76mVA	193.59mVA	
VAr	324.89mVAr	-193.26mVAr	
pf	0.073	+0.058	
voltage	3.6878V	2.2899V	+000.00°
current	88.335mA	84.535mA	-086.65°
frequency	30.000kHz		
H3	4.9618mW	43.83%	
dc watts	68.838uW		

Real time data

APPLICATIONS

■ PWM Motor Drive Evaluation PPA5500 PPA4500

The PPA5500 is the perfect solution for Inverter Drive evaluation and analysis. Utilising proprietary digital filtering algorithms, the N4L power analyzer range offers unrivalled performance. In high current applications the PPA5500 can be used in conjunction with external current sensors such as the LEM IT-400-S - a 150kHz to 500kHz galvanically isolated current transformer. Inverter efficiency is available via either 3 Phase 2 Wattmeter method + CH3 (utilising CH3 for the DC Bus measurement). Alternatively a second single phase PPA can be connected to the DC Bus and the two analyzers are configured in a Master Slave arrangement, all data is available via N4L Software.

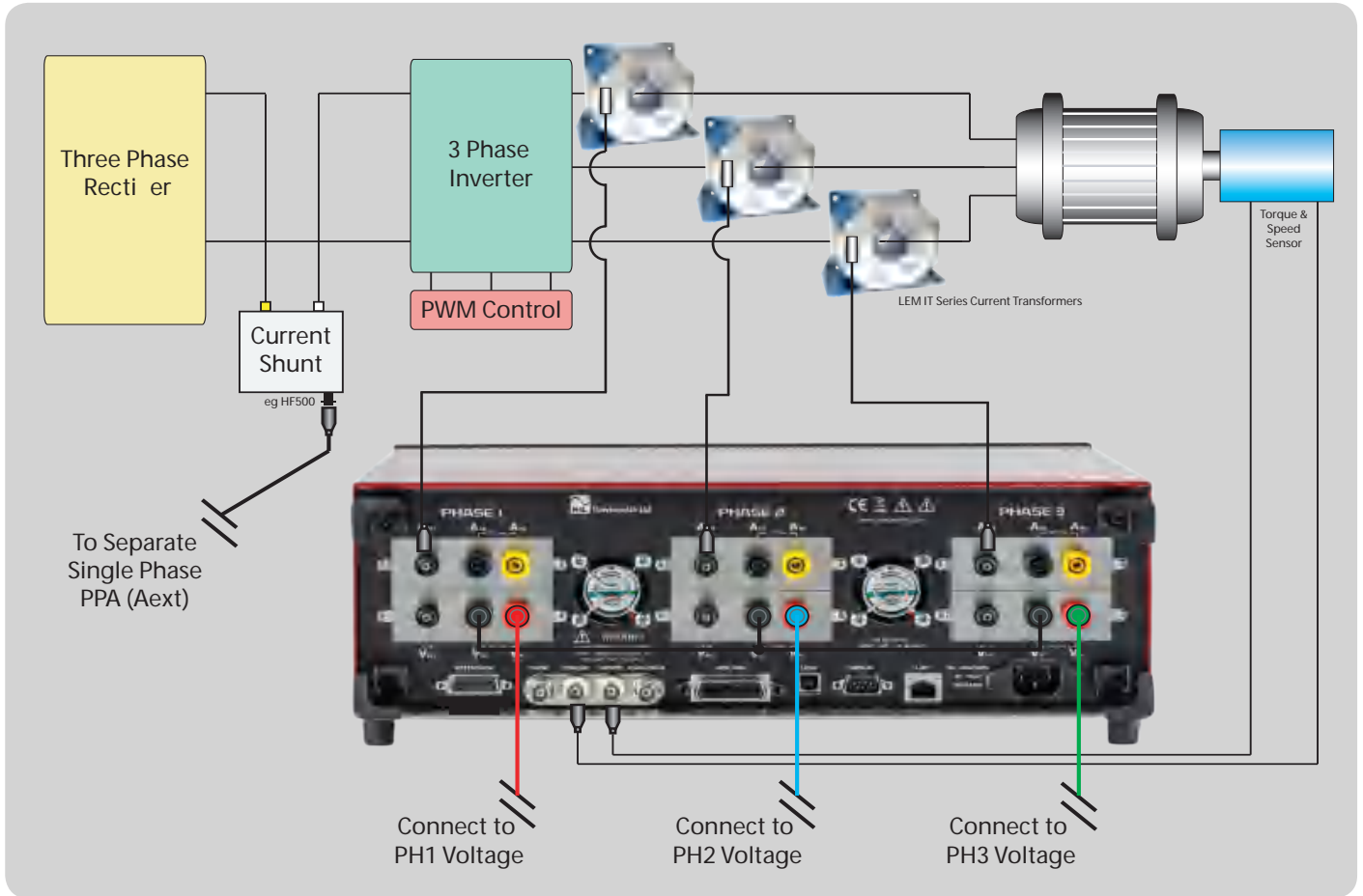

■ High Speed Analysis PPA5500

The PPA5500 features the fastest signal processing on the market, this enables high speed tracking of changing inverter drive frequencies and power parameters during ramp up and ramp down conditions, for example in electric vehicle applications. N4L's free to download software package (PPALoG) offers datalog intervals down to 5ms, providing fast, no-gap real-time data direct to software.

Rapid ramp up analysis



APPLICATIONS

■ Standby Power (IEC62301 Ed 2.0) PPA5500 PPA4500

The PPA4520 and PPA5520 units offer unrivalled dynamic range which enables the user to comply with IEC62301 and Energy Star testing standards. Utilising "Standby Power Mode" the PPA employs proprietary standby power signal processing algorithms to provide accurate no gap analysis of high crest factor (CF) signals, importantly the entire N4L power analyzer range benefit from a guaranteed accuracy specification up to a crest factor of 20.

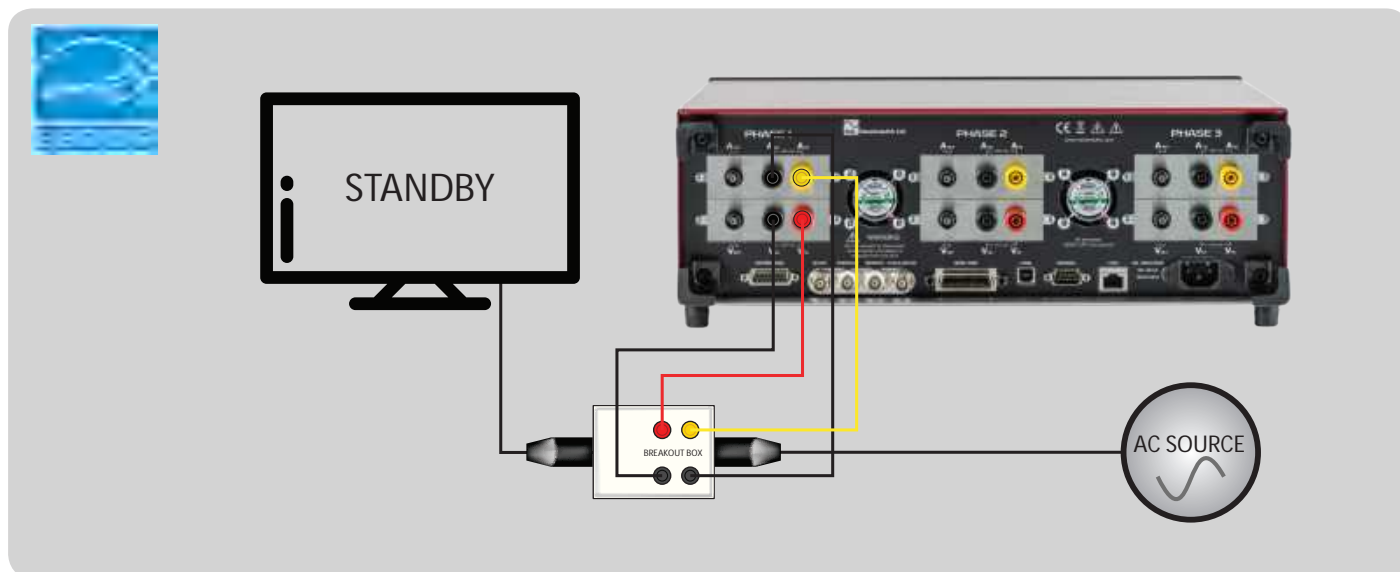

■ Guaranteed Accuracy up to Crest Factor 20 PPA5500 PPA4500

As stated in IEC62301, typical standby power current waveform crest factors can exceed values of 10. In such cases it is important for the Power Analyzer to guarantee accuracy at crest factors expected of the application under test.

Newtons4th are the only Power Analyzer Manufacturer in the world* to provide ISO17025 calibration certificates on all new Power Analyzers as standard. Our ISO17025 Schedule of Accreditation includes Voltage, Current, Phase, Power, Harmonics and Flicker. With traceable certification of power accuracy down to 0.5W, N4L offer the ideal measurement solution for certified standby power measurement.

■ LED Driver Efficiency PPA5500 PPA4500

The PPA4520 and PPA5520 offer an ideal solution for LED driver efficiency measurements, dimming techniques such as reverse phase control are easily analyzed by the N4L Power Analyzers.

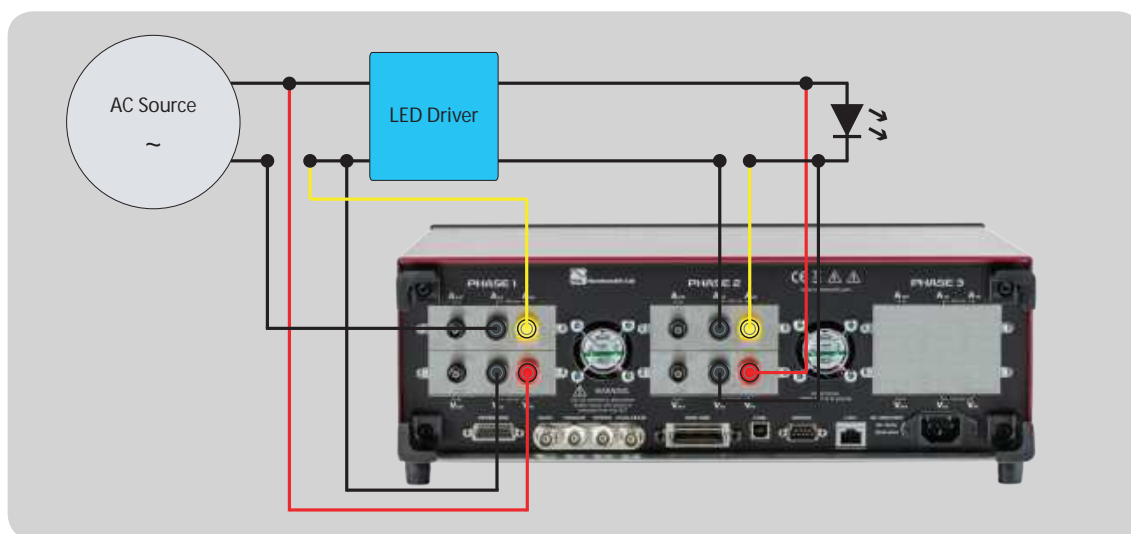

Efficiency can be viewed either directly on the PPA display using the "Phase/Next Phase" efficiency option or calculated in PPALog software.



APPLICATIONS

Power Transformer Loss Testing PPA5500 PPA5500-TE Transformer Edition

Both the PPA4500 and PPA5500 series Power Analyzers incorporate a unique analogue input design and proprietary digital signal processing techniques that exhibit a market leading standard phase accuracy of 0.005°. This inherent phase accuracy is optimised further within the new PPA5500-Transformer Edition to provide an ideal transformer core loss testing solution in accordance with the IEC60076-8 standard. See our separate PPA5500-TE brochure for full specification details including UKAS ISO17025 accredited certification and extended calibration interval.

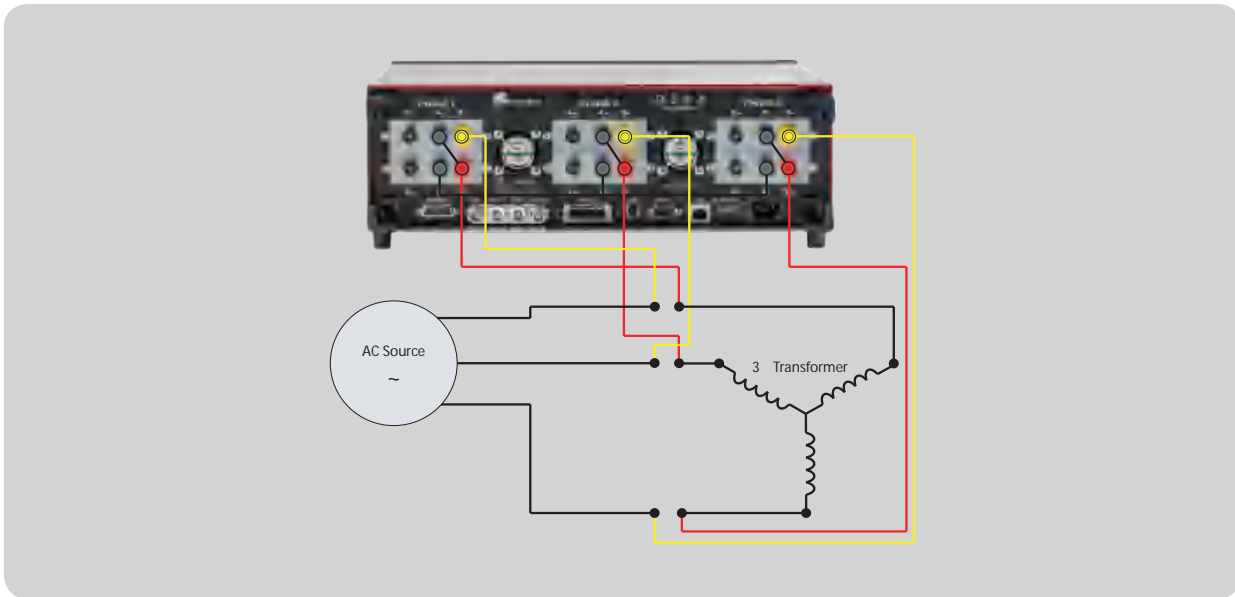

Aircraft Avionics Industry - 417 Harmonics + Interharmonics PPA5500

The PPA5500, featuring high speed FPGA and DSP processors is able to compute up to 417 Harmonics and also meet interharmonic measurement requirements of multiple avionic specifications. The Harmonic Analyzer mode and special TTVF105 Interharmonic mode in the PPA5500 offer the Avionics Engineer an accurate, simple to use solution.

Example ABD0100.1.8 Interharmonic Results, up to 150kHz (Sample Waveform analyzed for illustration)

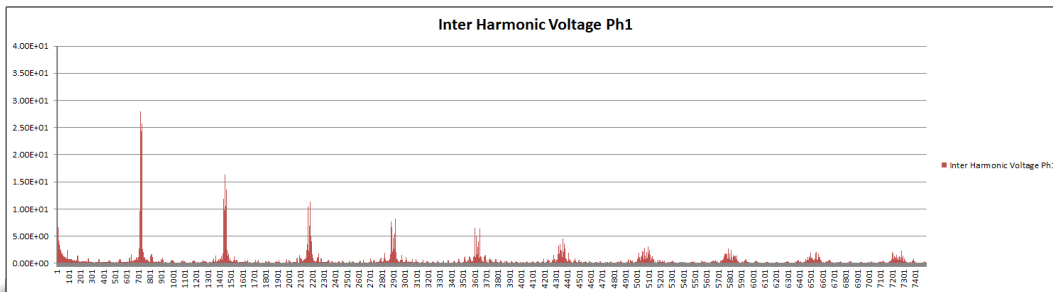

DO-160G		
Harmonic content	400Hz to 50kHz	○
Amplitude error	< 3% to 50kHz	○
Phase error	< 5° to 50kHz	○
Sampling rate	≥100kHz	○
Anti-aliasing filter	≥100kHz	N/A
Windowing	Rectangular	○
Harmonic Bandwidth	6dB - 10Hz to 10th Harmonic 100Hz to 40th Harmonic	N/A
Max hold	Detection option	○

ABD0100.8.1E		
Harmonic content	400Hz to 150kHz	○
Amplitude error	5% of permissible limit	○
Harmonic data	Fundamental Magnitude Phase Angle Integer frequency from Fund to 150kHz Dc current	○

ABD0100.1.8.1C		
As - ABD0100.8.1E plus:		
Subharmonics	0 to 150kHz	○
Amplitude error V&I	3% to 150kHz	○

AMD-24C		
As - ABD0100.8.1C without subharmonics		

Boeing 787B30147 RevC		
As - DO-160G except		
Sampling rate	≥200kHz	○
Anti-aliasing filter	75kHz to 125kHz	N/A
Tabulation of harmonic magnitude and phase (optional)	360Hz to 22.32kHz and 800Hz to 49.6kHz (equal to 62 harmonics)	○

Key	
○	Matches specification
○	Exceeds specification
N/A	Specification is not relevant due to PPA design methology

APPLICATIONS

Solar Inverter Performance Analysis PPA5500 PPA4500

The PPA5500 and PPA4500 provide a highly accurate solar inverter analysis and evaluation solution, featuring independent frequency detection N4L Power Analyzers exhibit the ability to synchronise to the 50/60Hz output signal along with with the DC input signal from the solar array. Both efficiency of the inverter, quality of the AC output and many other performance parameters can be recorded.

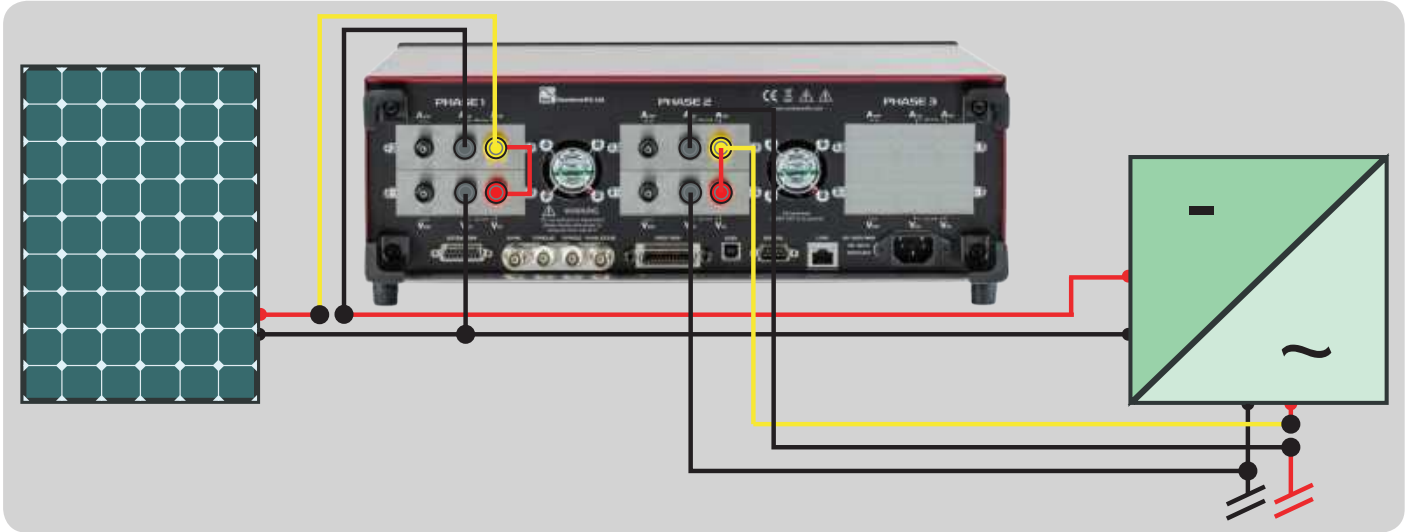

Inrush Current PPA5500 PPA4500

Accurate inrush current measurements rely upon two factors aside from fundamental measurement accuracy, these are gapless measurement and a high sampling rate;

1. Gapless Measurement - Inrush waveforms by their nature are transient; gapless measurement is vitally important in order to ensure that inrush waveform data is not missed.

2. High Sampling Rate - When working with mains frequencies, many power analyzers have low sample rates due to the computation of measured values from a data block of finite size. The PPA4500 and PPA5500 utilise a proprietary real time signal processing technique that maintains full 2.2Ms/s sample rate irrespective of the measured load frequency, ensuring that high frequency events are captured without aliasing.



Example Inrush current data, datalogging at nominally 20ms intervals directly to PPALoG

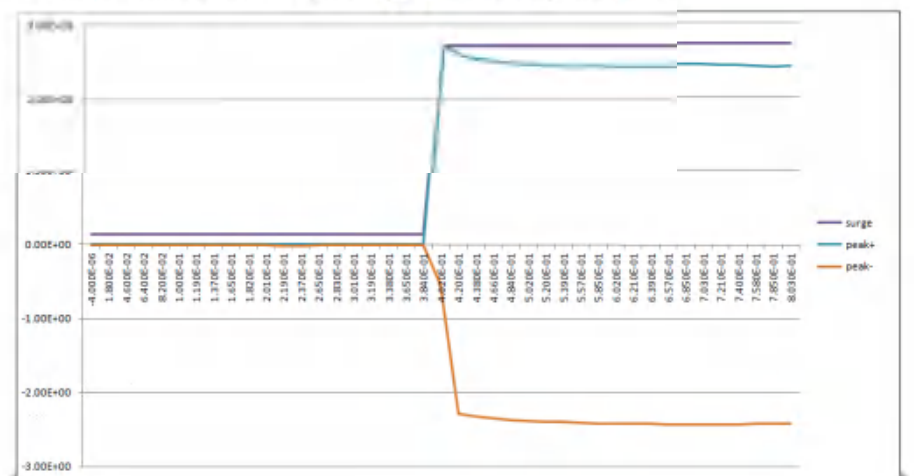

Calibration and ISO17025 Certification

UKAS PPA5500 PPA4500

Newtons4th are an accredited UKAS Calibration laboratory, all PPA4500 and PPA5500 Power Analyzers are supplied with an ISO17025 UKAS Calibration Certificate as standard. Calibration of N4L Power Analyzers is an integral and important part of our service to our clients, we offer quick turnaround times at a competitive price. Re-Calibration is also available at our international offices and various distributors throughout the world*.



7949

Schedule of Accreditation PPA5500 PPA4500

N4L's schedule of accreditation to ISO17025 is wide ranging and an overview of the schedule is detailed below, for more specific information, please see the UKAS website to view the full accreditation schedule.

ISO17025 UKAS Accreditation Schedule		
	Signal Amplitude	Frequency Range
Voltage Sine Amplitude	1V to 1008V	16Hz to 850Hz
Voltage Harmonic Amplitude	0V to 302V	16Hz to 6kHz
Current Sinewave Amplitude	100mA to 48A	16Hz to 850Hz
Current Harmonic Amplitude	0A to 15A	16Hz to 6kHz
Current to Voltage Phase Angle	-180° to +180°	16Hz to 850Hz
Apparent Power (VA Product)	100mVA to 48.4kVA	16Hz to 850Hz
AC Power	0W to 48.4kW	16Hz to 850Hz
AC Power - Calorimetry [New for 2017]	1W to 5W	45Hz to 2MHz
Current Harmonic Amplitude to IEC61000-4-7	0A to 6A	16Hz to 6kHz
Flicker to IEC61000-4-15	Pinst(Sinusoidal Modulation)	As per IEC61000
	Pinst(Rectangular Modulation)	
	Pst	
	Frequency Changes	
	Distorted Voltage with Multiple Zero Crossings	
	Harmonics with Sidebands	
	Phase Jumps	
Rectangular Changes with Duty Cycle d(t)		
IEC61000-4-15 Impedance Networks	Resistance, Reactance	33 mΩ to 400 Ω



Additional Calibration Options - IEC61000 / TE / HF PPA5500

By including with every PPA45/55 instrument both our 2MHz** wideband calibration detailed below and also ISO17025 accredited calibration, N4L assure compliance with our complete specification including the enhanced detail associated with IEC61000, TE and HF specifications. For those who require separate ISO17025 accredited certification of Harmonics, Flicker, Low PF Phase or High Frequency Power accuracy, these are available as calibration options.

Due to the specialist nature of Power Measurement Instrumentation Calibration, N4L utilise both commercially available calibration equipment (such as the Fluke 6105A for UKAS Certification) along with N4L bespoke designed signal generation equipment in order to calibrate our instruments over the full frequency range (up to 2MHz). Calibration over the full frequency range is uncommon given that such signal generation equipment is not commercially available. When supplied with an N4L analyzer, all customers will receive a calibration certificate covering the complete frequency range.



* UKAS Calibration is available from N4L UK HQ only, details for calibration performed at other locations is subject to local accreditation, please contact your local office for more details.
 ** 1MHz for 50A versions

Ranging Principles

■ 9 Stage Solid State Ranging System - PPA5500 PPA4500

Combining highly linear voltage attenuator and current shunt designs with a proprietary 9 stage (PPA5500) or 8 stage (PPA4500) solid state ranging system on every phase input, the PPA series achieve a uniquely wide dynamic range, with no need to switch between voltage attenuators or current shunts when ranging up or down.

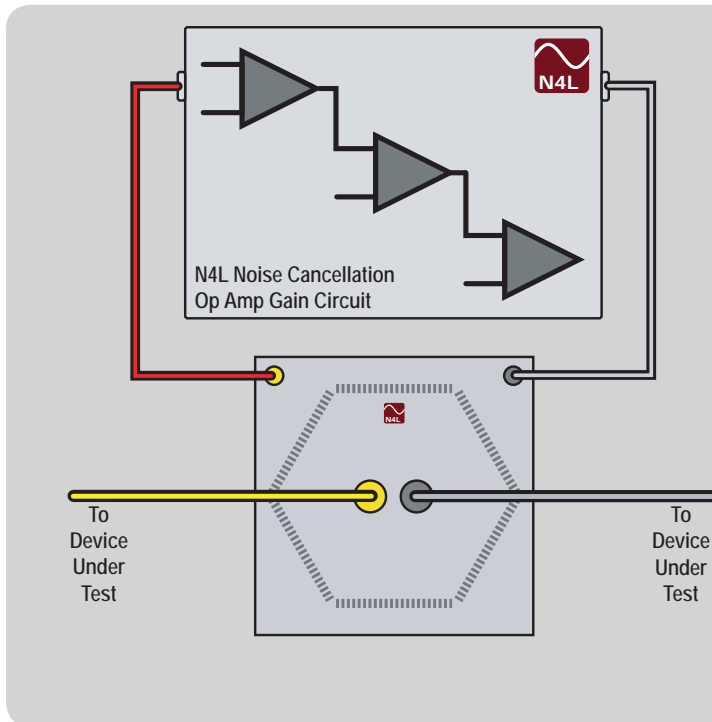

Design features:

- Single attenuator on each voltage input
- High impedance low capacitance
- Single shunt on each current input
- Low impedance low inductance
- Auto peak detect
- High speed solid state ranging
- High Noise rejection
- Auto DC offset trimming

Benefits:

- Overload protected on any range
- Low shunt affect on voltage connections
- Low voltage burden on current connections
- Market leading phase accuracy
- Peak detect ranging ensures no signal clipping
- Low attenuator/shunt operating temperature
- Fast range switching
- Constant frequency response on all ranges
- Signal can be applied with instrument powered off

■ Auto Peak Ranging Ensures Complete Waveform Analysis PPA5500 PPA4500

It is often overlooked that for an instrument to correctly calculate power parameters, the entire waveform must be digitised for analysis. The Peak Ranging system employed by all N4L Power Analyzers ensures that the entire waveform is digitised and the correct power parameters are calculated.

Example RMS Ranging system, commonly used in older instrument designs

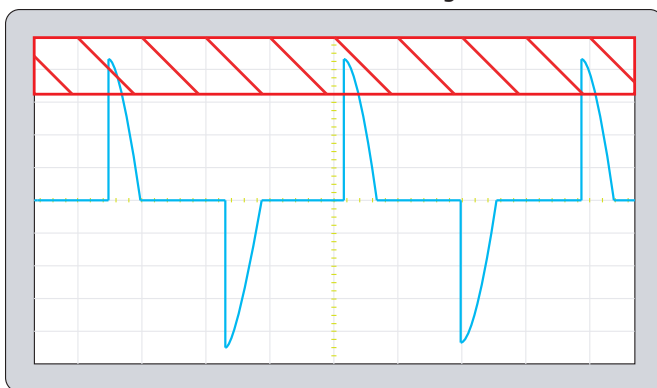

Waveform within red hashed area is clipped by an RMS ranging system and fixed crest factor setting

Modern Peak Ranging System, implemented on all N4L Power Analyzers

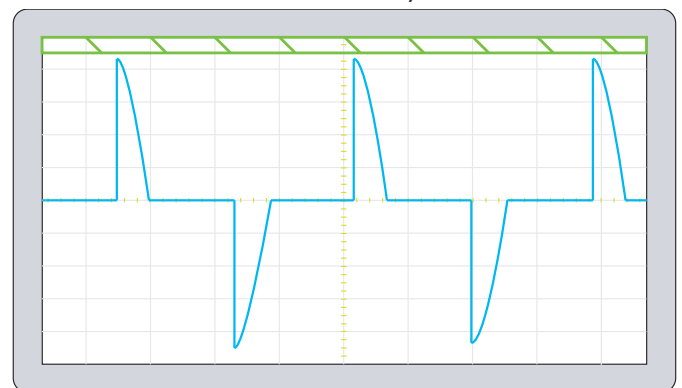

Peak Ranging system auto-detects the peak of the input signal and selects the ideal range

Note

An RMS Ranging system requires the user to have prior knowledge of the crest factor which in many applications is not practical, either because the user cannot reasonably be expected to know this value before a measurement, or because the crest factor is changing during a measurement period. The ideal ranging system is therefore based upon peak detection which does not require the user to be concerned with a crest factor setting. While many RMS ranging systems are only guaranteed to support a Crest Factor of 6, all N4L Power Analyzers guarantee to auto-range with any crest factor and maintain full accuracy with a CF of at least 20. While waveforms with a true CF above 20 are very unusual, 'auto range up' or 'manual' ranging combined with a market leading range sensitivity enables the PPA to achieve a dynamic range equal to a CF >300.

PC CONTROL AND DATA ACQUISITION

PC Software PPA5500 PPA4500

Analysis carried out by the instrument can easily be transferred to a PC via USB, RS232 or LAN

① **PPALoG** Exceptional flexibility and ease of use with all the functions included in the original PPAcomm program plus multiple instrument control for 4-12 phase applications and data export to Text file, Excel, Bitmap or Clipboard

a. Measurement parameters are chosen by the user from tick box options
 b. Real time results can be displayed as latest value, table or graph
 c. Datalogging results are then saved in the selected format

Simultaneous display of master and slave units

Real time Datalog

Capture up to 60 measured functions per line

Data Export options

A Bitmap image of any PPA screen image can be copied to clipboard or imported directly into documents

Measurement tables generated by the data logging function can be exported directly to Excel

② **PPA Standby Power** Full compliance testing to IEC62301. Meets or exceeds the requirements and methodology of U.S. EPA (Energy Star), U.S.DOE, California Energy Commission (CEC), among others.

Standby power test screen with real time update of IEC62301 criteria

On completion of the standby test, a full test report can be exported directly to a spreadsheet

PC CONTROL AND DATA ACQUISITION

Fully Compliant IEC61000-3-2/3-3 Harmonics and Flicker Testing PPA5500

The PPA55xx series Power Analyzers provide fully compliant ISO17025 certified Harmonics and Flicker testing, Newtons4th provide fully integrated software featuring real time and graphical user interfaces as well as excel and pdf exporting functionality.

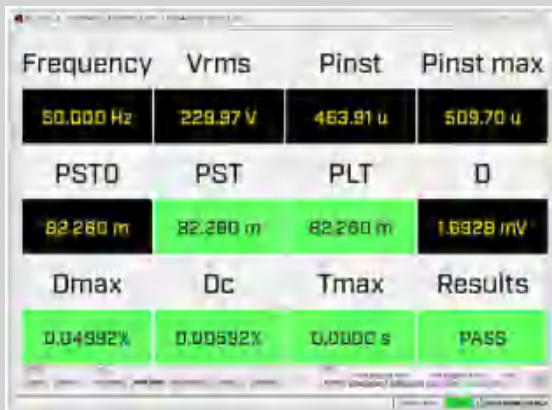

Flicker tests are automatically evaluated against the IEC/BSEN or JIS limits and a pdf/excel report is generated indicated PASS/FAIL.

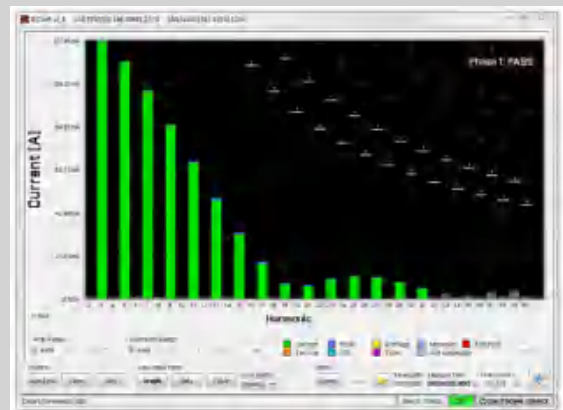

Both graphical and real time displays are available when testing to IEC61000-3-2/3/11/12. The graphs are colour coded to assist the test engineer.

More information is available in a separate IEC61000 Harmonics and Flicker brochure. Dedicated models called the PPA5511 and PPA5531 include low impedance shunts (see ** on page 20) and adjusted filter response for full compliance testing.

Connection Interface PPA5500 PPA4500

RS232, USB, LAN & GPIB* All standard fitment on PPA5500

*(GPIB Optional on PPA4500)



Data Logging PPA5500 PPA4500

Utilizing sophisticated frequency detection techniques, synchronization with the fundamental AC waveform is automatically achieved. Datalog intervals can be set from 2ms with measurements saved to a PC or internal memory.

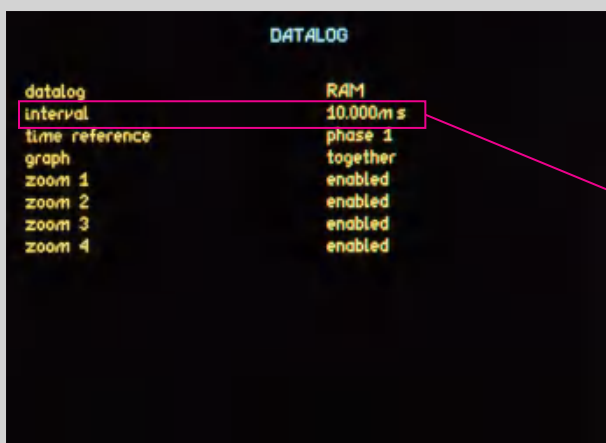

Datalog menu, interval set to 10ms

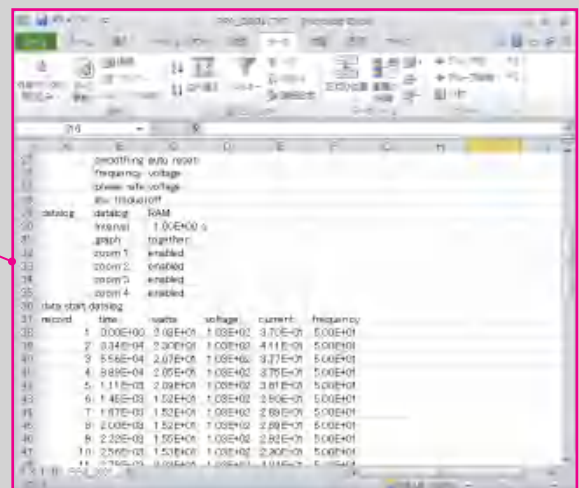

SPECIFICATION

		PPA4500	PPA5500		
Frequency Range					
		DC*,10mHz ~ 2MHz - PPA4500-LC(10Arms), PPA4500-Std(30Arms) DC*,10mHz ~ 1MHz - PPA4500-HC(50Arms)	DC*,10mHz ~ 2MHz - PPA5500-LC(10Arms), PPA5500-Std(30Arms) DC*,10mHz ~ 1MHz - PPA5500-HC(50Arms)		
Voltage Input					
Internal	Range	1Vpk ~ 3000Vpk(1000Vrms) in 8 ranges (240Vrms within 300Vpk range, using 20% overage)	300mVpk ~ 3000Vpk(1000Vrms) in 9 ranges (240Vrms within 300Vpk range, using 20% overage)		
	Accuracy	0.03% Rdg+0.04% Rng+(0.004%×kHz Rdg)+5mV	0.01% Rdg+0.038% Rng+(0.004%×kHz Rdg)+5mV		
	Impedance	3Mohm in parallel with 5pF - Common mode capacitance to chassis 90pF			
External	Range	1mVpk ~ 3Vpk in 9 ranges [BNC connector 3Vpk max input]	300μVpk ~ 3Vpk in 9 ranges [BNC connector 3Vpk max input]		
	Accuracy	0.03%Rdg+0.04%Rng+(0.004%×kHz Rdg)+3μV	0.01%Rdg+0.038%Rng+(0.004%×kHz Rdg)+3μV		
	Impedance	1Mohm in parallel with 40pF - Common mode capacitance to chassis 90pF			
Current Input					
Internal	10Arms Low Current (PPA5500-LC) 4mm safety connectors	Ranges	10mApk ~ 30Apk(10Arms) in 8 ranges	Ranges	3mApk ~ 30Apk(10Arms) in 9 ranges
		Accuracy	0.03% Rdg+0.04% Rng+(0.004%×kHz Rdg)+ 30μA	Accuracy	0.01% Rdg+0.038% Rng+(0.004%×kHz Rdg)+ 30μA
	30Arms Current (PPA5500-Std) 4mm safety connectors	Ranges	100mApk ~ 300Apk(30Arms) in 8 ranges	Ranges	30mApk ~ 300Apk(30Arms) in 9 ranges
		Accuracy	0.03% Rdg+0.04% Rng+(0.004%×kHz Rdg)+ 300μA	Accuracy	0.01% Rdg+0.038% Rng+(0.004%×kHz Rdg)+ 300μA
	50Arms High Current (PPA5500-HC) **	Ranges	300mApk ~ 1000Apk(50Arms) in 8 ranges	Ranges	100mApk ~ 1000Apk(50Arms) in 9 ranges
		Accuracy	0.03% Rdg+0.04% Rng+(0.004%×kHz Rdg)+ 900μA	Accuracy	0.01% Rdg+0.038% Rng+(0.004%×kHz Rdg)+ 900μA
External input (External shunt Current sensor)	BNC Connector (Max input 3Vpk)	Ranges	1mVpk ~ 3Vpk in 8 ranges	Ranges	300μVpk ~ 3Vpk in 9 ranges
		Accuracy	0.03% Rdg+0.04% Rng+(0.004%×kHz Rdg)+ 3μV	Accuracy	0.01% Rdg+0.038% Rng+(0.004%×kHz Rdg)+ 3μV
Phase Accuracy See PPA5500-TE brochure for TE specification					
0.005deg+(0.01deg×kHz) [PPA45/5500-LC(10Arms), PPA45/5500(30Arms)] 0.01deg+(0.02deg×kHz) [PPA45/5500-HC(50Arms)]					
Power Accuracy					
10mHz-2MHz	LC/Std	[0.04%+0.05%/pf+(0.01%×kHz)/pf] Rdg+0.04%VA Rng	[0.03%+0.03%/pf+(0.005%×kHz)/pf] Rdg+0.03%VA Rng		
	HC	[0.04%+0.05%/pf+(0.01%×kHz)/pf] Rdg+0.06%VA Rng	[0.03%+0.03%/pf+(0.01%×kHz)/pf] Rdg+0.03%VA Rng		
40-850Hz		[0.03%+0.04%/pf+(0.01%×kHz)/pf] Rdg+0.03%VA Rng	[0.02%+0.03%/pf+(0.005%×kHz)/pf] Rdg+0.01%VA Rng		
16-450Hz Low PF			See PPA5500-TE Brochure		
General					
Crest Factor	20(Voltage and Current)				
Sample Rate	2.2Ms/s on all channels, No-Gap				
IEC Modes	IEC62301 Standby Power		IEC61000 Harmonics and Flicker, IEC62301 Standby Power		
Application Modes	PWM Motor Drive, Ballast, Inrush, Power Transformer, Standby Power		PWM Motor Drive, Ballast, Inrush, Power Transformer, Standby Power, Fluctuating Harmonics, Flicker Meter, TVF105 Interharmonics		
CMRR - Common Mode Rejection Ratio					
250V @ 50Hz - ≥ 1mA (150dB)					
100V @ 100kHz - ≥ 3mA (130dB)					
Measurement Parameters					
W ,VA ,Var ,pf ,V & A - rms ,rectified mean ,AC ,DC ,Peak ,Surge ,Crest Factor ,Form Factor ,Star to Delta Voltage, +ve Pk, -ve Pk					
Frequency (Hz), Phase (deg), Fundamentals, Impedance					
Harmonics, THD, TIF, THF, TRD, TDD					
Integrated Values, Datalog, Sum and Neutral values					
Datalog - Up to 4 user selectable measurement functions (30 with optional PC software)					
Datalog Window	No-Gap analysis, Minimum window 10ms		No-Gap analysis, Minimum window 2ms		
Memory	16,000 records		10M records into flash RAM (Non-Volatile)		
Communication Ports					
RS232	Baud rate up to 38.4kbps,RTS/CTS flow control				
LAN	10/100 Base-T Ethernet auto sensing				
GPIB	(Option G) IEEE488.2 Compatible		(Fitted as standard) IEEE488.2 Compatible		
USB	USB 2.0 and 1.1 compatible				
Analogue O/P	Bipolar ±10V(BNC)				
Speed & Torque I/P	BNC Bipolar±10V or Pulse count 1Hz to 1MHz 0.01% Rdg				
Sync	4 ~ 6 Phase measurement (Master/Slave)				
Extension	4 ~ 6 Phase (Master/Slave) + Auxiliary				
Standard Accessories					
Leads	Power, RS232, USB		Power, RS232, USB		
Connection Cables	36A 1.5m long 4mm stackable terminals: 1x red, 1x yellow and 2x black per phase (1x red, 1x black with HC version)				
Connection Clips	4mm terminated alligator clips - 1x red, 1x yellow and 2x black per phase (1x red and 1x black per phase with PPA5500-HC version)				
CD-ROM	CommView2 (RS232/USB/LAN), Command line, Script based communication software				
Documents	User manual, Communications manual, Calibration certificate, Quick start guide				
Mechanical/Environmental					
Input Impedance	Voltage Attenuator 3MΩ 5pF	External Inputs 1MΩ 40pF	Common mode capacitance to chassis 90pF		
Display	320×240 dot full colour TFT, White LED Backlit				
Dimensions	130H×400W×315D mm excluding feet				
Weight	5.4kg(1 Phase), 6kg(3 Phase)				
Safety Isolation	1000Vrms or DC(CATII), 600Vrms or DC(CATIII)				
Power supply	90 ~ 265Vrms, 50 ~ 60Hz, 40Vamax				
Operating / Storage Conditions	Ambient Operating Temperature 0 to 50°C (or air intake temperature when rack mounted), Storage Temperature -10 to 60°C, 20-95% Relative Humidity Non-Condensing, Maximum Altitude 2,000m Temperature coefficient ±0.02% per °C of reading at 5-18°C and 28-40°C				

*DC Specification available separately

SPECIFICATION

	PPA4500	PPA5500
Harmonic Specification		
Bandwidth	DC*,10mHz ~ 2MHz - PPA4500-LC(10Arms), PPA4500-Std(30Arms) DC*,10mHz ~ 1MHz - PPA4500-HC(50Arms)	DC*,10mHz ~ 2MHz - PPA5500-LC(10Arms), PPA5500-Std(30Arms) DC*,10mHz ~ 1MHz - PPA5500-HC(50Arms)
No. of Harmonics	100	417
Sampling Frequency	2Ms/s	
Signal Processing	DFT (Discreet Fourier Transform)	
Crest Factor	20	
Power Factor	0 to 1	
Harmonic Accuracy		
Voltage	0.03% Rdg+0.04% Rng+(0.004%×kHz Rdg)+5mV	0.01% Rdg+0.038% Rng+(0.004%×kHz Rdg)+5mV
Current	PPA4500-LC 0.03% Rdg+0.04% Rng+(0.004%×kHz Rdg)+10uA PPA4500-Std 0.03% Rdg+0.04% Rng+(0.004%×kHz Rdg)+300uA PPA4500-HC 0.03% Rdg+0.04% Rng+(0.004%×kHz Rdg)+900uA	PPA5500-LC 0.01% Rdg+0.038% Rng+(0.004%×kHz Rdg)+10uA PPA5500-Std 0.01% Rdg+0.038% Rng+(0.004%×kHz Rdg)+300uA PPA5500-HC 0.01% Rdg+0.038% Rng+(0.004%×kHz Rdg)+900uA
Harmonic Accuracy (above) still applies with Frequency Filter set		
IEC61000 Harmonic Accuracy		
Voltage	-	0.2% Rdg+0.038% Rng+(0.004%×kHz Rdg)+5mV
Current	-	PPA5500-LC 0.2% Rdg+0.038% Rng+(0.004%×kHz Rdg)+10uA PPA5500-Std 0.2% Rdg+0.038% Rng+(0.004%×kHz Rdg)+300uA PPA5500-HC 0.2% Rdg+0.038% Rng+(0.004%×kHz Rdg)+900uA
Cycle by Cycle Analysis direct to PC - 2Ms/s sample rate (Window setting)		
Data Rate	10ms	5ms
Cycle by Cycle Analysis direct to Internal RAM - 2Ms/s sample rate		
Data Rate	10ms	2ms
Voltage Attenuator Overload Capability		
20ms	4.2kVpk (3kVrms)	4.2kVpk (3kVrms)
5s	3.1kVpk (2.2kVrms)	3.1kVpk (2.2kVrms)
Continuous	3kVpk (1.5kVrms)	3kVpk (1.5kVrms)
Minimum Current Measurement at Full Accuracy		
PPA5500-LC	45uArms	45uArms
PPA5500-Std	220uArms	220uArms
PPA5500-HC	700uArms	700uArms

*DC Specification available separately

STANDARD ACCESSORIES AND DOCUMENTS

Leads and Interfacing	
Type	Specification
36A Connection lead set	1.5 Meter - 36A lead set with 4mm stackable safety terminals 1x Red, 1x Yellow and 2x Black per phase plus alligator clips
36A 4mm to spade (Option)	1.5 Meter - 36A lead set with 4mm to spade for HC terminals
RS232 cable	RS232 9pin serial Cable
USB cable	USB 2 Meter A male to B male
USB to 9-pin RS232 (Option)	USB ~ 9-pin RS232 Serial Converter
Master-Slave cable (Option)	Leads for connecting 2x PPA5500 in master/slave mode

Documents	
Type	Specification
Test, Inspection & Calibration	PPA Certificate of Calibration - Full bandwidth verification
UKAS ISO17025 Certificate	UKAS ISO17025 Certificate of Calibration - 40 to 850 Hz
Manuals	Quick Start manual & Communications manual

OPTIONAL CALIBRATION

Additional calibration options - ISO17025 Accredited	
Type	Specification
IEC61000	Harmonics and Flicker certification to IEC61000 standards
System Calibration	Combined PPA + External Current Sensor 'system' certification
TE - Transformer Edition	Certified compliance to TE specification
HF - High Frequency	Certified compliance to PPA High frequency specification

PC SOFTWARE - FREE DOWNLOAD

PC Software - Free to Download from Newtons4th.com (CD Copy is a charged option)	
Type	Specification
PPALoG	PC control and data acquisition of 1 ~ 12 phases with selectable Real Time data, Graphing, Datalog and versatile export options
PPAcomm	Basic PC Control, Data storage, Print features
PPA Standby Power	Standby power measurements and reporting to IEC62301
PPAsoft PC software	LabView based software, PC Control, Data storage and Print
IECSOft	IEC61000 Testing Software

HARDWARE OPTIONS

Interface	
Type	Specification
PPA-GPIB interface	Option G - GPIB(IEEE488)Interface (Standard on 55 series)

Rack Mount Kit	
Type	Specification
Rack Mount brackets	PPA26/5500 19in rack mount brackets (model specific)
Rack Mount panel	PPA2500 19in rack fascia panel

Connection and extension port accessories	
Type	Specification
Breakout box	Simple analyzer connection between source and DUT
PCIS	10Arms 300Apk rated Phase Controlled Inrush Switch
GPIB Communication Cable	GPIB Communication Cable Option (Port Fitted as standard on PPA5500)



Breakout Box

Carry cases	
Type	Specification
Soft carrying case	Black nylon with shoulder strap
Hard flight case	Hard case with moulded lining suitable for shipping

PPA Series Hard Carrying Case



PPA500/1500 MODELS

For more details see separate brochure

Phases	Model	Specification
1 Ph	PPA1510/510*	DC, 10mHz ~ 1MHz 100mApk ~ 300Apk (20Arms)
2 Ph	PPA1520/520*	
3 Ph	PPA1530/530*	
1 Ph	PPA1510/510-HC*	DC, 10mHz ~ 1MHz 300mApk ~ 1000Apk (30Arms)
2 Ph	PPA1520/520-HC*	
3 Ph	PPA1530/530-HC*	

*PPA500 DC, 10mHz ~ 500kHz



PPA500 3 Phase model

ACCESSORIES

High Performance Voltage Attenuating Probes			
Model	Voltage Range	Frequency Range	Details
TT-HV250	2500Vpk	300MHz	High Voltage Probe (Passive) 2.5kVpk 100:1
TTV-HVP	1500Vpk	50MHz	High Voltage Probe (Passive) 15kVpk 1000:1
ATT10	30Vpk	30MHz	10:1 Voltage Attenuator Box (For use in conjunction with HV Probes when output voltage of probe is >3Vpk, BNC Input/BNC Output)
ATT20	60Vpk	30MHz	20:1 Voltage Attenuator Box (For use in conjunction with HV Probes when output voltage of probe is >3Vpk, BNC Input/BNC Output)
ULCP	3000Vpk	2MHz	1000:1 Ultra Low Capacitance Probe (Active), For use in applications such as Ballast Testing (<1pF Capacitance)



TT-HV250 2.5kVpk Probes



TTV-HVP 15kVpk Probes



ATT10



ULCP

High Performance External Current Measurement Options					
Model Number	Measuring Range	Frequency Range	Basic Accuracy	Phase Accuracy	Details
HF003	3Arms - 30Apk	DC - 1MHz	470mΩ (±0.1%)	0.0001° / kHz	3Arms External Current Shunt, BNC Output (Use with PPA External Input)
HF006	6Arms - 60Apk	DC - 1MHz	100mΩ (±0.1%)	0.001° / kHz	6Arms External Current Shunt, BNC Output (Use with PPA External Input)
HF020	20Arms - 200Apk	DC - 1MHz	10mΩ (±0.1%)	0.01° / kHz	20Arms External Current Shunt, BNC Output (Use with PPA External Input)
HF100	100Arms - 1000Apk	DC - 1MHz	1mΩ (±0.1%)	0.05° / kHz	100Arms External Current Shunt, BNC Output (Use with PPA External Input)
HF200	200Arms - 2000Apk	DC - 1MHz	0.5mΩ (±0.1%)	0.1° / kHz	200Arms External Current Shunt, BNC Output (Use with PPA External Input)
HF500	500Arms - 5000Apk	DC - 1MHz	0.2mΩ (±0.1%)	0.1° / kHz	500Arms External Current Shunt, BNC Output (Use with PPA External Input)



External Shunt HF-003



External Shunt HF-100



External Shunt HF-200



External Shunt HF-500

Probe/Current Clamp Transformer: AC							
Model Number	Measuring range	Frequency range	Accuracy	Details	Clamp diameter	Category	
M3 UB 50A-1V	100mA ~ 50A	40Hz ~ 5kHz	1%	100mA to 50A AC Current Clamp	15mm×17mm	600V CATIII	
M3 U 100A-1V	1A ~ 100A	40Hz ~ 5kHz	1%	1A to 100A AC Current Clamp	15mm×17mm	600V CATIII	
S UE 200A-1V	1A ~ 200A	40Hz ~ 5kHz	1%	1 A to 200A AC Current Clamp	50mm ø	600V CATIII	
S UE 250 500 1000-1V	1A ~ 250A/500A/1000A	40Hz ~ 5kHz	1%(250A) 0.5%(500+1000A)	1 A to 250/500/1000A AC Current Clamp	50mm ø	600V CATIII	
US UE 1000A-1V	1A ~ 1000A	40Hz ~ 5kHz	1%	1A to 1000A AC Current Clamp	43mm ø	600V CATIII	
SM UE 1000A-1V	0.5A ~ 1000A(1%>100A)	15Hz ~ 15kHz	1%	0.5A to 1000A AC Current Clamp	54mm ø	600V CATIII	
SM UB 1000A-1V	0.5A ~ 1000A(0.5%>10A)	15Hz ~ 15kHz	0.5%	0.5A to 1000A AC Current Clamp	54mm ø	600V CATIII	
P32 UE 1000A-1V	5A ~ 1000A	40Hz ~ 5kHz	1%	5 A to 1000A AC Current Clamp	83mm ø (125mm×47mm or 100mm m×58mm)	600V CATIII	
P32 UE 3000A-1V	5A ~ 3000A	40Hz ~ 5kHz	1%	5 A to 3000A AC Current Clamp	83mm ø	600V CATIII	



Current Clamp M3-UB 50A-1V



Current Clamp S-UE 200A-1V



Current Clamp SM-UB 1000A-1V



Current Clamp P32-UE 1000A-1V

Probe / Current Clamp (Hall effect): AC + DC

Model number	Measuring range	Frequency range	Accuracy	Details	Clamp diameter	Category
SC 2C 100A-1V	1A ~ 100A	DC ~ 5kHz	2%	1A to 100A AC+DC Current Clamp	50mm ø	600V CATIII
SC 3C 1000A-1V	1A ~ 1000A	DC ~ 2kHz	1%	1A to 1000A AC+DC Current Clamp	59mm ø	600V CATIII
P20 3C 2000A-2V	40A ~ 1000/2000A	DC ~ 2kHz	1%	40A to 2000A AC+DC Current Clamp	83mm ø	600V CATIII
P40 3C 4000A-2V	40A ~ 2000/4000A	DC ~ 2kHz	1.5%	40A to 4000A AC+DC Current Clamp	83mm ø	600V CATIII
P50 3C 5000A-2V	50A ~ 2000/5000A	DC ~ 2kHz	1.5%	50A to 5000A AC+DC Current Clamp	83mm ø	600V CATIII



Current Clamp SC 2C 100A-1V



Current Clamp SC 3C 1000A-1V



Current Clamp P20 3C 2000A-2V



Current Clamp P50 3C 5000A-2V

Rogowski Current Transducer: AC / Zero Flux Current Transducer: AC+DC

Model number	Measuring range	Frequency range	Nominal Accuracy	Details	Coil/Through Hole Circumference	Category
WR5000 Rogowski	1A ~ 5000A	1Hz ~ 1MHz	0.05%	1A to 5000A AC Rogowski Coil	600mm	600V CATIII
WR10000 Rogowski	1A ~ 10000A	1Hz ~ 1MHz	0.05%	1A to 10000A AC Rogowski Coil	600mm	600V CATIII
LEM IT 60-S	0A ~ 60A DC/pk (42Arms)	DC ~ 800kHz	0.01%	60A Zero Flux Current Transducer	26mm	600V CATIII
LEM IT 65-S	0A ~ 60A DC / 85A pk (60Arms)	DC ~ 800kHz	0.01%	60A Zero Flux Current Transducer	26mm	600V CATIII
LEM IT 200-S	0A ~ 200A DC/pk (141Arms)	DC ~ 500kHz	0.01%	200A Zero Flux Current Transducer	26mm	600V CATIII
LEM IT 205-S	0A ~ 200A DC / 283A pk (200Arms)	DC ~ 1MHz	0.01%	200A Zero Flux Current Transducer	26mm	600V CATIII
LEM IT 400-S	0A ~ 400A DC/pk (282Arms)	DC ~ 500kHz	0.01%	400A Zero Flux Current Transducer	26mm	600V CATIII
LEM IT 405-S	0A ~ 400A DC / 566A pk (400Arms)	DC ~ 300kHz	0.01%	400A Zero Flux Current Transducer	30mm	600V CATIII
LEM IT 700S	0A ~ 700A DC/pk (495Arms)	DC ~ 100kHz	0.01%	700A Zero Flux Current Transducer	30mm	300V CATIII
LEM IT 1000S	0A ~ 1000A DC/pk (707Arms)	DC ~ 500kHz	0.01%	1000A Zero Flux Current Transducer	30mm	300V CATIII
LEM IT 605S	0A ~ 600A DC / 849A pk (600Arms)	DC ~ 300kHz	0.01%	600A Zero Flux Current Transducer	30mm	300V CATIII
LEM IT 600S	0A ~ 600A DC/pk (425Arms)	DC ~ 300kHz	0.01%	600A Zero Flux Current Transducer	30mm	300V CATIII
LEM ITN 900S	0A ~ 900A DC/pk (636Arms)	DC ~ 300kHz	0.01%	900A Zero Flux Current Transducer	30mm	300V CATIII
LEM ITN 1000S	0A ~ 1000A DC/pk (707Arms)	DC ~ 300kHz	0.01%	1000A Zero Flux Current Transducer	30mm	300V CATIII
LEM IN 1000-S	0A ~ 1000A DC / 1500Apk (1000Arms)	DC ~ 440kHz	0.01%	1000A Zero Flux Current Transducer	38.2mm	1000V CATII
LEM IN 2000-S	0A ~ 2000A DC / 3000Apk (2000Arms)	DC ~ 140kHz	0.01%	2000A Zero Flux Current Transducer	70mm	1000V CATIII

LEM Interfaces

Model number	Description	Compatibility	Nominal Accuracy
LEM6/X Interface	Combined PSU + Configurable Load Resistor interface for connecting up to 6 LEM transducers to PPA	All LEM transducers listed above except IT 1000-S, ITN 1000-S, IN 1000-S and IN 2000-S	0.1%
LEM-1 Interface	Individual interface Inc. load resistor for connecting LEM transducer to PPA.	All LEM transducers listed above	0.1%
LEM-1 PSU	50W or 120W LEM-1 Power Module @ ±15V Output	All LEM transducers listed above	N/A



WR5000 Rogowski Coil



LEM-1 Interface

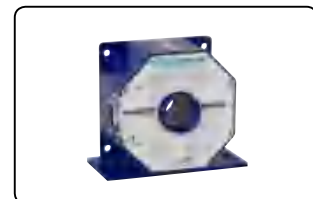

LEM IT 700-S



PPA5500 3 Phase model



PPA5500 units in Master/Slave mode, synchronised for 4-6 Phase measurements



PRODUCT COMPARISON

	PPA500	PPA1500	PPA3500	PPA4500	PPA5500
Basic Accuracy					
V, A rdg error	0.05%	0.05%	0.05%	0.03%	0.01%
Power rdg error	0.10%	0.10%	0.06%	0.04%	0.02%
Phase Options					
Internal	1~3	1~3	1~6	1~3	1~3
Master/Slave operation	—	—	—	4~6	4~6
Bandwidth					
20 & 30A Shunt	DC ~ 500kHz	DC ~ 1MHz	DC ~ 1MHz	—	—
10 & 30A Shunt	—	—	—	DC ~ 2MHz	DC ~ 2MHz
50A Shunt	—	—	—	DC ~ 1MHz	DC ~ 1MHz
Voltage Input					
Max input voltage	2500Vpk	2500Vpk	2500Vpk	3000Vpk	3000Vpk
No. of ranges	8	8	10	8	9
Direct Current Input					
10Arms model	—	—	—	○	○
20Arms model	○	○	○	—	—
30Arms model	○	○	○	○	○
50Arms model	—	—	—	○	○
No. of ranges	8	8	10	8	9
Features					
Scope and Graph Modes	—	○	○	○	○
USB Memory port	○	○	○	○	○
LAN Port	○	○	○	○	○
GPIB Port	○	○	○	○	○
RS232 Port	○	○	○	○	○
Real time clock	○	○	○	○	○
19in Rack mount option	○	○	○	○	○
Torque and Speed	—	—	○	○	○
IEC61000 Mode	—	—	—	—	○
PWM Motor Drive Mode	—	Limited Functionality	○	○	○
Oscilloscope	—	○	○	○	○
Transformer Mode	—	—	○	○	○ TE version
PWM Filter Options	—	2	7	7	7
Speed/Harmonics/Sec	300/sec	300/sec	300/sec	600/sec	1800/sec
Internal Datalogging	4 Parameters	4 Parameters	32 Parameters	16 Parameters	16 Parameters
Datalog Records	16000	16000	5M	5M	10M
ABD0100.1.8 Mode	—	—	—	—	○
Internal Memory	192kB	192kB	500MB	500MB	1GB
Harmonics	50	50	100	100	417
Minimum Window Size	10ms	5ms	5ms	2ms	2ms
Dimensions - Excl. Feet H x W x D (mm)	92 x 215 x 312	92 x 215 x 312	87.5H x 400W x 347D mm	130 x 400 x 315	130 x 400 x 315
Weight	3.3 - 4kg	3.3 - 4kg	5 - 7kg	5.4 - 6kg	5.4 - 6kg

— Not Applicable ○ Option ● Standard

All specifications at 23°C ± 5°C. These specifications are quoted in good faith but Newtons4th Ltd reserves the right to amend any specification at any time without notice.

The N4L product range also includes Frequency Response and Impedance Analyzers, Selective Level Meters and Laboratory Power Amplifiers



PSM3750
10µHz ~ 50MHz



PSM17xx
10µHz ~ 35MHz

Applications

Newtons4th Ltd

- Power supply phase margin and gain margin (FRA)
- Inductance, Capacitance and Resistance (LCR)
- Analysis of mechanical vibration (HARM)
- Phase Angle Voltmeter (PAV)

Contact your local N4L Distributor for further details

Newtonson4th

Newtons4th Ltd (abbreviated to N4L) was established in 1997 to design, manufacture and support innovative electronic equipment to a world-wide market, specialising in sophisticated test equipment particularly related to phase measurement. The company was founded on the principle of using the latest technology and sophisticated analysis techniques in order to provide our customers with accurate, easy to use instruments at a lower price than has been traditionally associated with these types of measurements. Flexibility in our products and an attitude to providing the solutions that our customers really want has allowed us to develop many innovative functions in our ever increasing product range.



Newtons4th Ltd are ISO9001 registered, the internationally recognised standard for the quality management of businesses



In recognition of the technical innovation and commercial success of the PPA series, N4L received the "Innovation 2010" Queen's award for enterprise

Distributed by:

Newtons4th Ltd
1 Bede Island Road
Leicester
LE2 7EA
UK
Phone: +44 (0)116 230 1066
Fax: +44 (0)116 230 1061
Email: sales@newtons4th.com
Web: www.newtons4th.com